

MANUAL DE INSTALACIÓN

CIAO 310 | Cód.: 004.008.1504

CIAO 340 | Cód.: 004.008.1505

CIAO 430 | Cód.: 004.008.1506

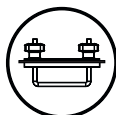

Todo el placer de viajar

A

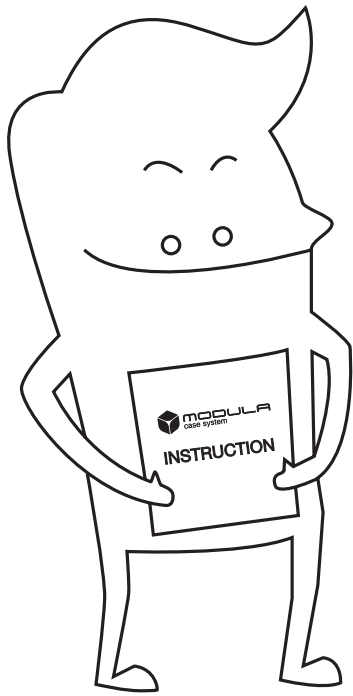

B

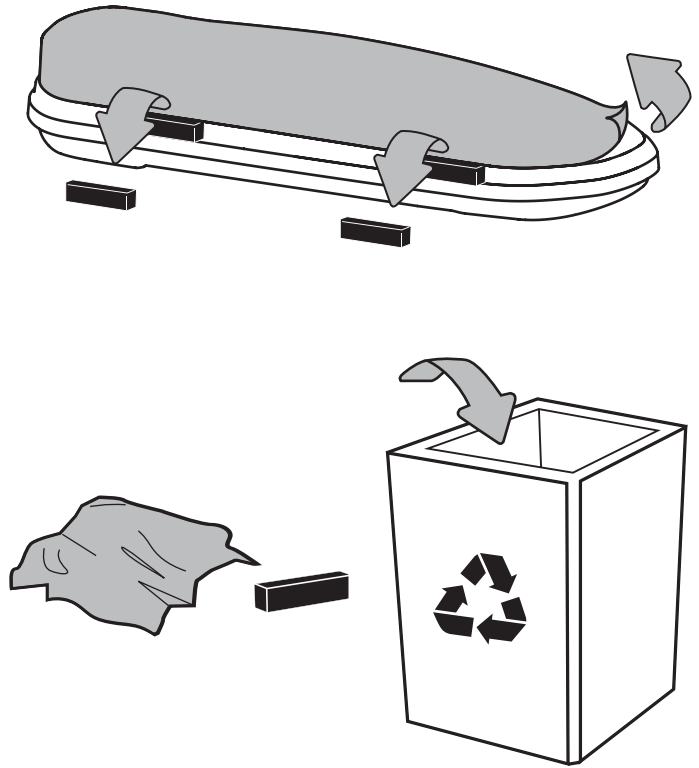

C

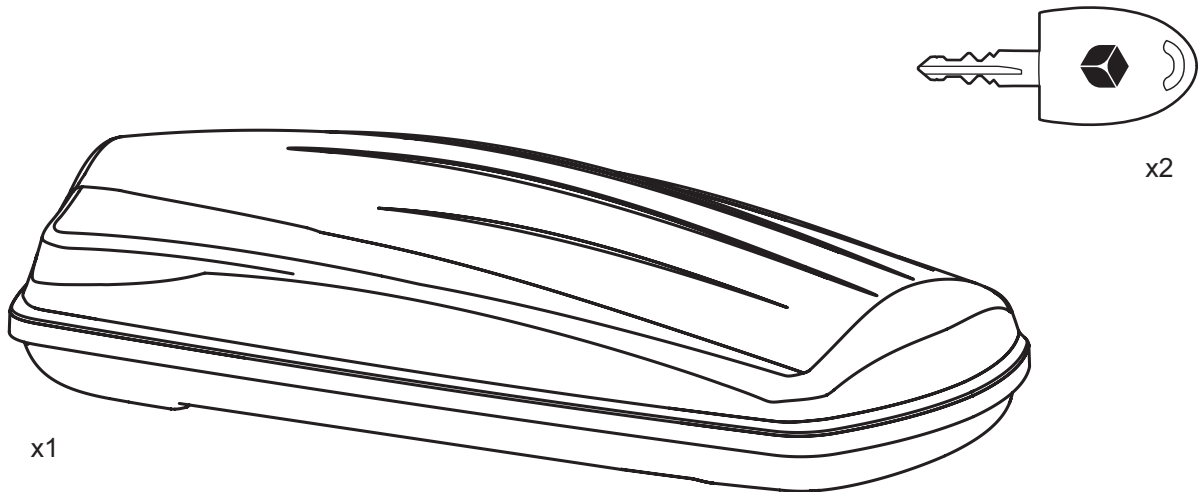

1

310 28 MIN | 79 cm MAX
340 19 MIN | 78 cm MAX
430 41 MIN | 98 cm MAX
580 60 MIN | 125 cm MAX

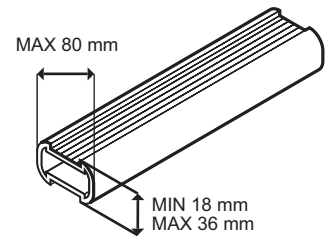
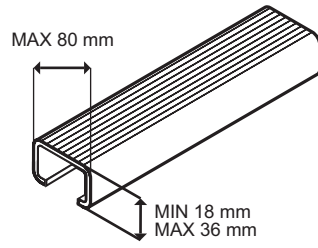
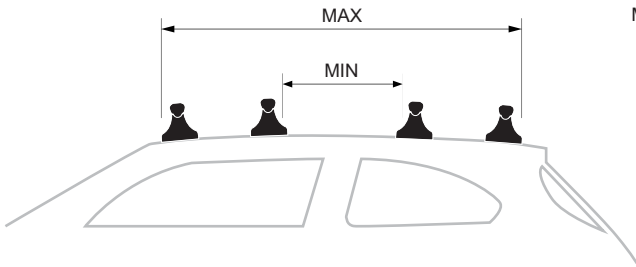

2

2.1

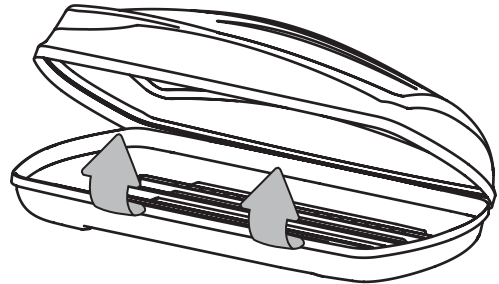
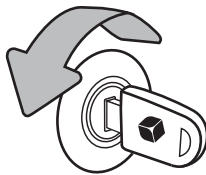
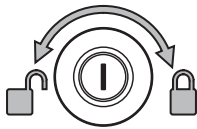

2.2

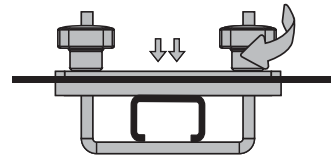
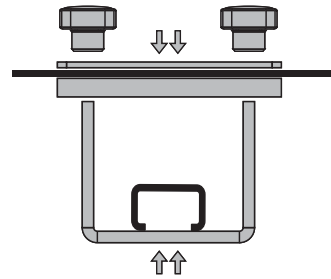
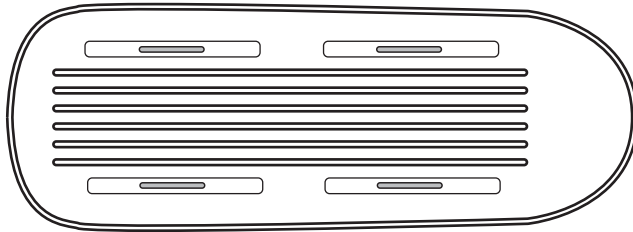
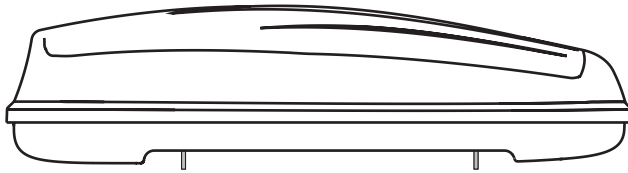

2.3

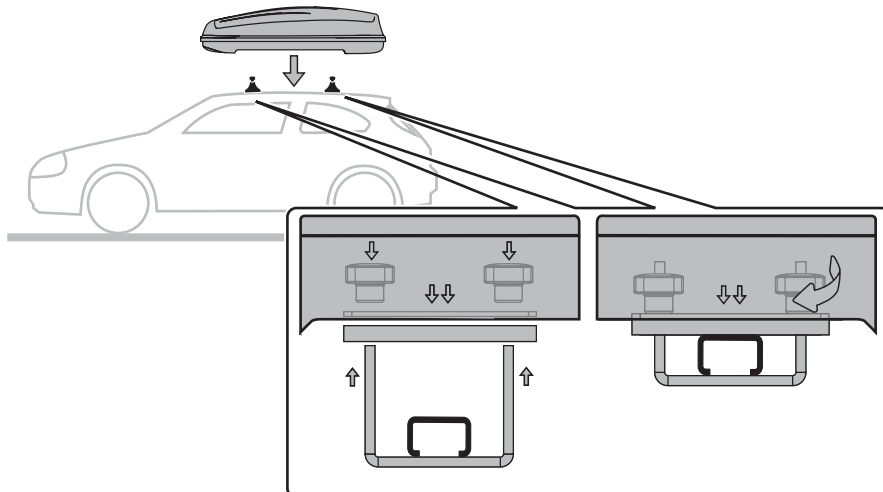

SI

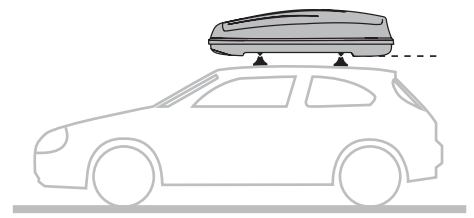
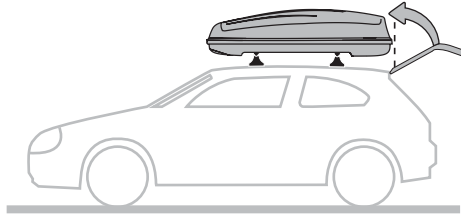
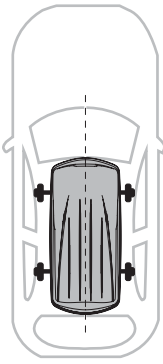

NO

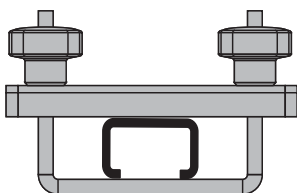
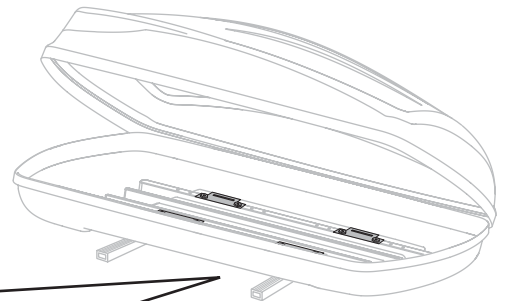
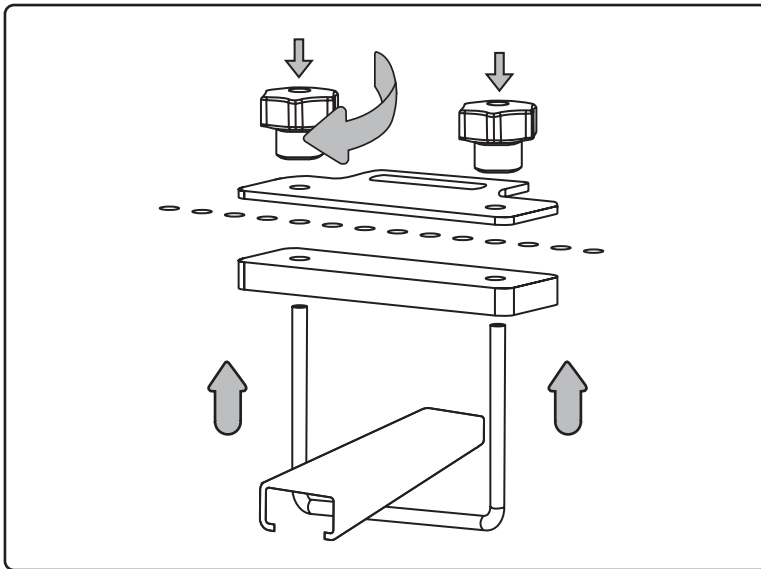
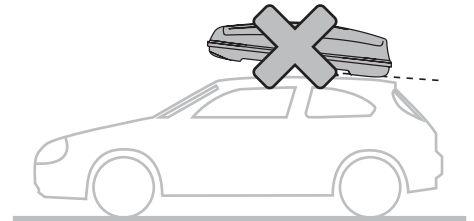
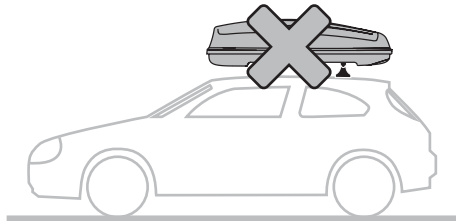
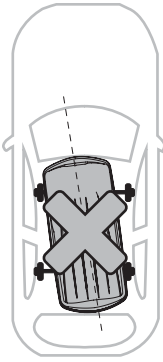

SI

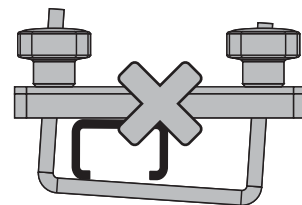

NO

4.1

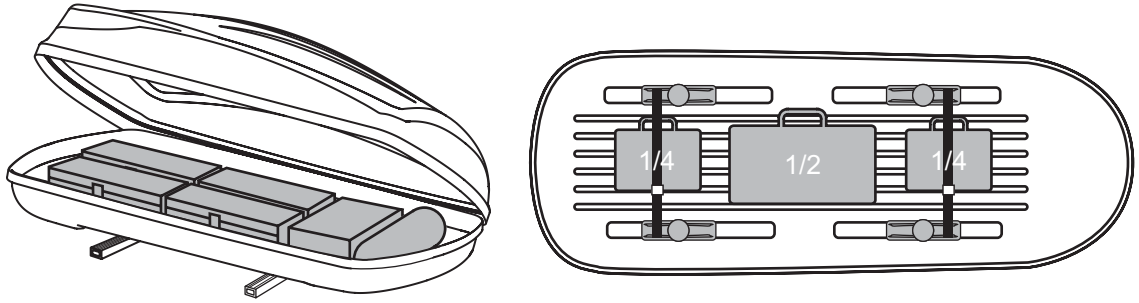

4.2

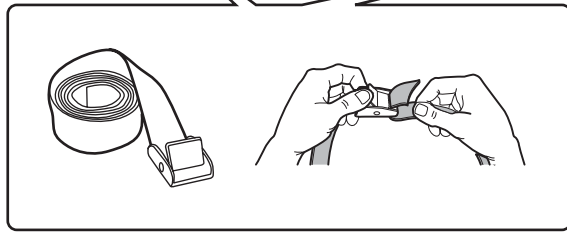
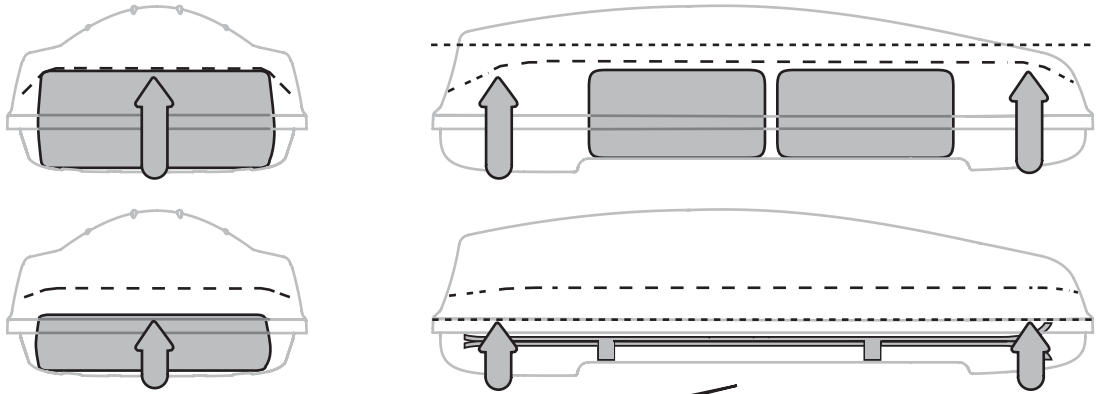

NO

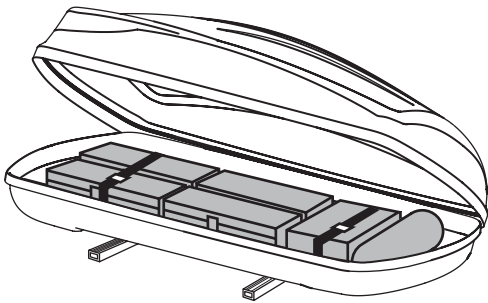
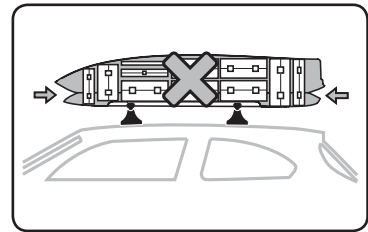

SI

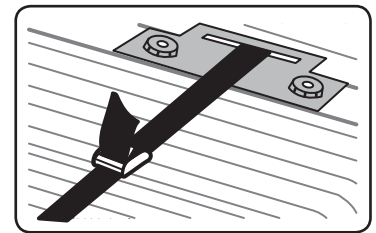

SI

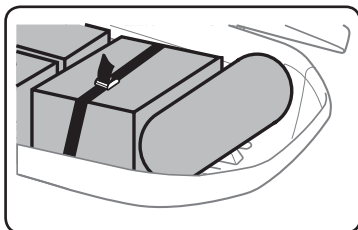

NO

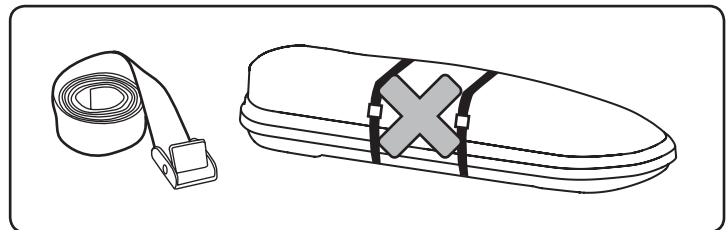

6

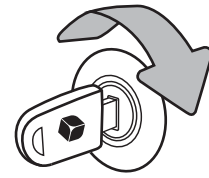
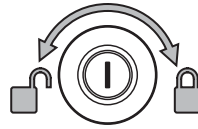
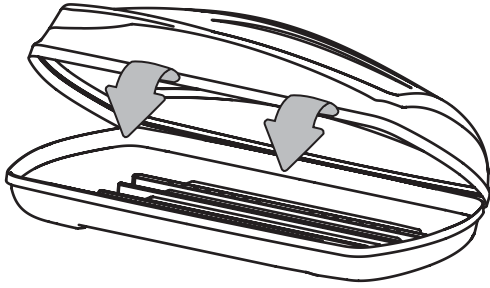

7

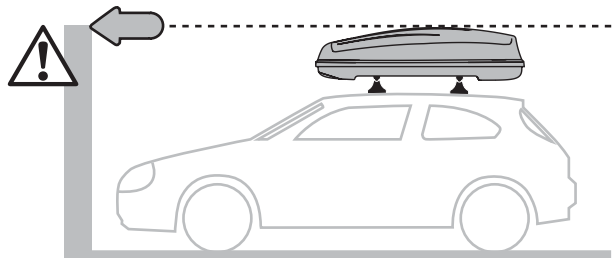
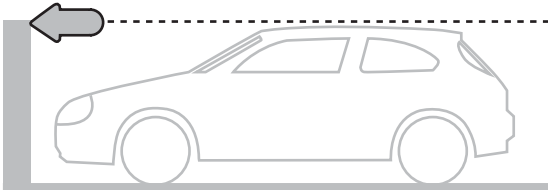

8

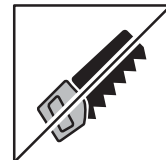
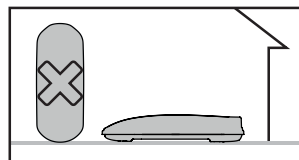
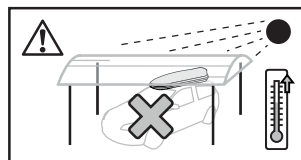
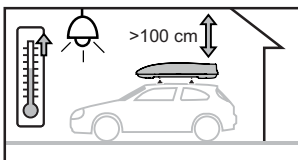
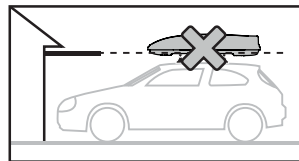
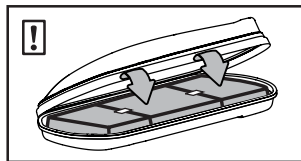
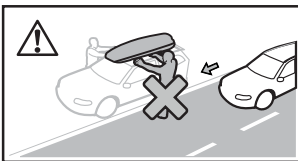
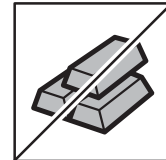
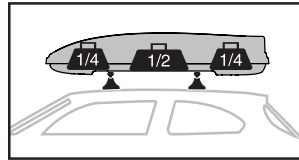
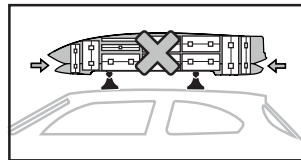
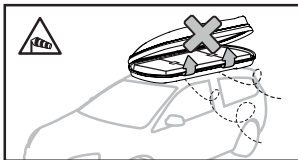
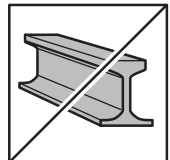
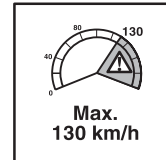
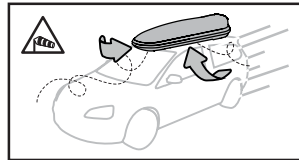
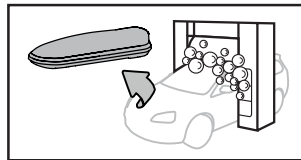
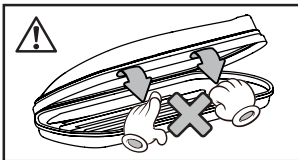

CIAO 310

Dimensiones | **Largo 126 Ancho 78 Alto 35 cm** | Volumen **310 litros** | Capacidad **75 kg** | Peso **7,4 kg**

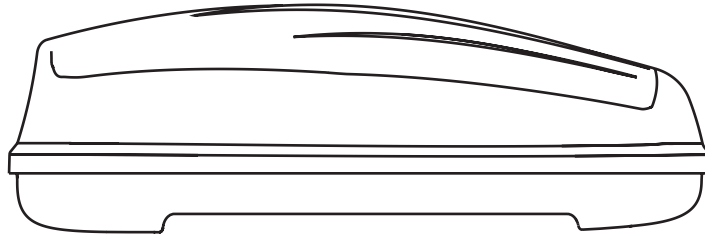
**CIAO 340**

Dimensiones | **Largo 140 Ancho 80 Alto 44 cm** | Volumen **340 litros** | Capacidad **75 kg** | Peso **11 kg**

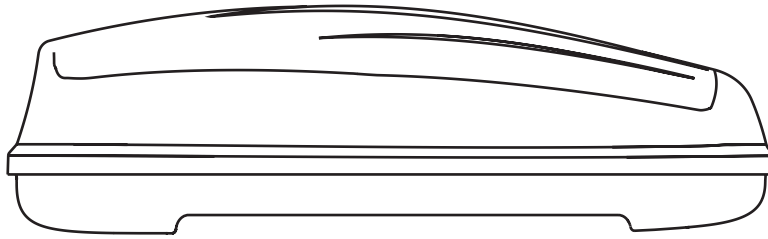
**CIAO 430**

Dimensiones | **Largo 175 Ancho 80 Alto 44 cm** | Volumen **430 litros** | Capacidad **75 kg** | Peso **12,4 kg**

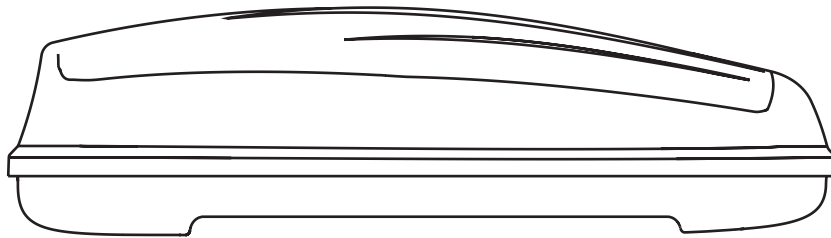

Requerimientos y recomendaciones:

Después de un viaje corto al principio y periódicamente, dependiendo de las condiciones de la carretera, las conexiones de pernos y la fijación del contenedor del techo deben ser comprobados y chequeados.

Tener en cuenta que la conducción del vehículo y su reacción cambia (vulnerabilidad lateral vientos, curvas y comportamiento de frenado) cuando el contenedor del techo está montado, especialmente cuando está cargado.

Por razones de seguridad de los demás participantes en el tráfico y por cuestiones de ahorro de energía, el contenedor del techo debe retirarse durante los períodos donde no este en uso.

La información declarada por el fabricante del vehículo, relativa a la carga de peso máxima permitida debe ser respetada. Considere el peso del contenedor, ya que la carga máxima permitida en el techo es una combinación de la carga real, sumando el peso de las barras y contenedor.

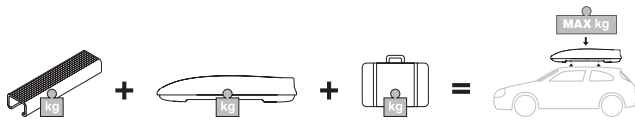

El baúl debe ser montado alineado a la dirección del vehículo y evitando ángulos de incidencia para disminuir la resistencia del viento y riesgos.

Advertencia:

- Es muy importante seguir las instrucciones de montaje y uso;
- Controle y chequee regularmente los dispositivos de fijación durante un viaje;
- Guarde este manual de instrucciones en un lugar seguro;
- Asegure la carga del contenedor en el techo de forma correcta y segura;
- Es importante mantener el equipo en buen estado para su correcto funcionamiento.

Requirements and recommendations:

After a short travel at first and specific time periods, depending on the road conditions, the bolt connections and the roof container fixing have to be checked.

The driving behavior of the vehicle changes (vulnerability to side winds, cornering and breaking behavior) when the roof container is mounted, especially when loaded.

By reasons of safety of other traffic participants and for matters of energy saving, the roof container should be taken off during periods of no use.

The information stated by the vehicle's manufacturer, concerning the permissible roof load, has to be followed.

Consider the weight of the container, since permissible roof load is a combination of the actual load, adding the weight of the roof racks and container.

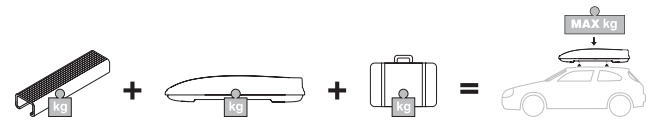

The roof container has to be mounted in direction of the travel without a positive angle of incidence, to avoid any increase in lifting forces.

Warning:

- It is very important to follow the instructions of fitting and use;
- Tighten and check the fixing devices correctly and regularly during travel;
- Keep this instruction manual safely;
- Secure the roof container load correctly and safe;
- It is important to maintain the equipment in good working order

